

# User Manual



VB0009



VB0008

## Ventilation Systems for residential use only

---

### MODELS

---

Solo 1.5

---

Solo 2.0

---

Duo 1.2

---

Duo 1.4

---

Duo 1.9

---

Address of your installer

## ABOUT THIS MANUAL/PRODUCT

The purpose of this manual is to help you with the use of your unit. Section 2 (How to Operate the Unit Using Controls) shows you how you can operate the unit in no time. Section 3 deals with maintenance and explains how to maintain the unit to ensure maximum operation and performance. In the other sections, for example troubleshooting, you will learn how to solve minor problems (Section 4); plus other important information which we urge you to read.

In simplifying explanations, all drawings (figures) in this manual show the unit installed in the “normal” position. However, please note that your unit can be installed in either the “normal” or “reverse” (upside down) position. Several models are described in this publication. Some details of your unit may be slightly different than the ones shown, as the illustrations are typical ones.

We welcome any suggestions you may have concerning this manual and/or the unit, and we would appreciate hearing your comments on ways to better serve you. Please forward all correspondence to us at the address indicated on the product’s registration card included with this manual.

This manual uses the following symbols to emphasize particular information:

### **WARNING**

**Identifies an instruction which, if not followed, might cause serious personal injuries including possibility of death.**

### **CAUTION**

**Denotes an instruction which, if not followed, may severely damage the unit and/or its components.**

NOTE: Indicates supplementary information needed to fully complete an instruction.

Finally, we want to congratulate you on your purchase of this excellent unit which will allow you and your family to enjoy fresh air throughout your home for years to come!

### **CAUTION**

**Some activities create dust or vapors which may damage your unit. You must therefore turn off and unplug your unit in the following situations:**

- major renovation work
- housing construction
- sanding (e.g. gypsum joints, etc.)
- varnishing

**During very heavy snowstorms, the unit should also be turned off to avoid problems caused by snow entering the unit, even if it is equipped with an anti-gust intake hood.**

---

# TABLE OF CONTENTS

---

<b>1.0</b>	<b>YOUR UNIT AND ITS PURPOSE</b>	<b>4</b>
1.1	<i>Unit Description</i>	4
1.2	<i>Purpose of the Ventilation System</i>	4
1.3	<i>Recovery</i>	5
1.4	<i>Filtration</i>	6
1.5	<i>Defrost Mode</i>	6
1.6	<i>Specifications</i>	6
<b>2.0</b>	<b>HOW TO OPERATE THE UNIT USING CONTROLS</b>	<b>7</b>
2.1	<i>Instructions Regarding your Control Devices</i>	7-8
2.2	<i>Using the Venta Main Control</i>	9
2.3	<i>Using the Supra Main Control</i>	10-11
2.4	<i>Using the Ultima Main Control</i>	12-13
2.5	<i>Using the Auxiliary Controls</i>	14-15
<b>3.0</b>	<b>MAINTENANCE</b>	<b>16</b>
3.1	<i>Every Three Months</i>	16-17
3.2	<i>Annual Maintenance (Fall)</i>	18-19
<b>4.0</b>	<b>TROUBLESHOOTING</b>	<b>20</b>

# 1.0 YOUR UNIT AND ITS PURPOSE

## 1.1 UNIT DESCRIPTION

1. Basic filters
2. Blower
3. Condensation tray (on Solo unit only)
4. Heat recovery core or thermal wheel
5. Optional filter

*\*Units shown in normal position. Can also be installed upside down.*

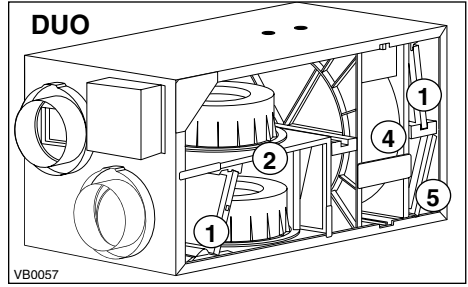
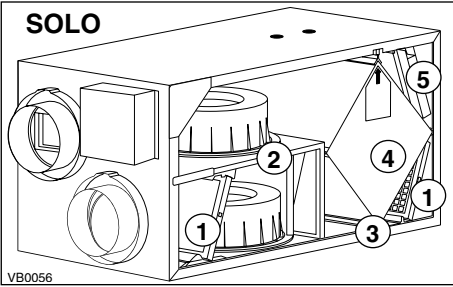

## 1.2 PURPOSE OF THE VENTILATION SYSTEM

Your ventilation system is designed to provide fresh air, warmed outdoor air to your home while exhausting stale, humid air from your home. By eliminating accumulated pollutants and humidity, it maintains an optimum air quality and an ideal relative humidity.

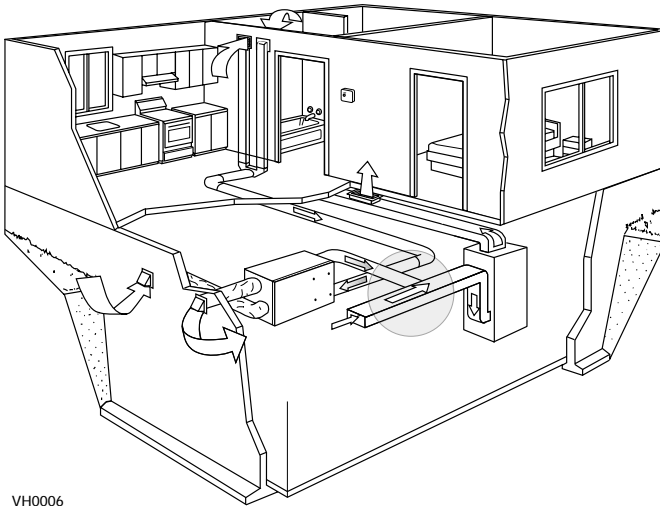

- NOTES: 1. Shown with a forced air system. Can also operate on its own.  
2. Installation may vary according to the model number and the position (normal or reverse) in which the unit is installed.

## 1.3 RECOVERY

- A) Units with a heat recovery core (**Solo units**) are designed specifically to control excess humidity and reduce ventilation costs by recovering the heat energy from the exhausted air, and using that same heat energy to warm the fresh air being supplied. This heat recovery process is accomplished in such a way that the stale air is never mixed with the fresh air.

### Example (in winter):

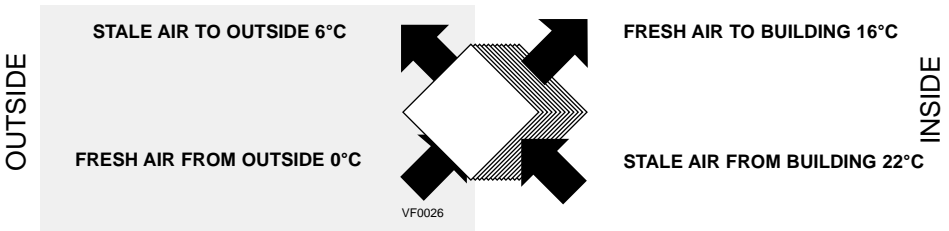

- B) Units equipped with a thermal wheel (**Duo units**) can reduce ventilation costs in winter as well as in summer by maintaining indoor humidity level for maximum comfort.

1. During the heating season, the unit draws the humidity and heat from the stale air and transfers them, in part, to the cold air entering the house, thus avoiding dryness problems and providing maximum comfort (**Example 1**).
2. During the cooling season, the unit reverses the process, preventing the humidity from the outside air from entering into the house (**Example 2**).

### Example 1 (in winter):

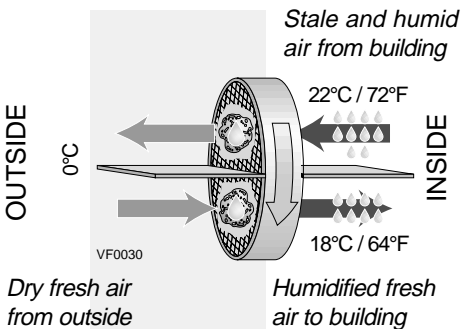

Heating season

### Example 2 (in summer with air conditioning):

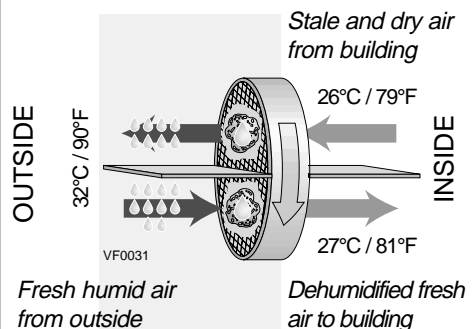

Cooling season

## 1.4 FILTRATION (only applicable to units operated with Ultima main control)

### A) Basic filtration:

While in filtration mode, the unit ceases to exchange air with the exterior. Continuous circulation and a mechanical filter ensure the purification of the ambient air inside the house. The mechanical filter traps dust particles visible to the eye.

### B) Optional filters (add-on to the basic filtration):

- **Pleated:** A second stage filter to trap dust particles.
- **Electronic:** Acts as the pleated model with increased efficiency.
- **Activated carbon:** Traps dust *particles* and *odors*.

## 1.5 DEFROST MODE

When the outside temperature is below -5°C (23°F), recovery (of heat or energy) creates frost in the module. To maintain its proper operation, the unit is programmed to defrost the recovery module. The defrost frequency varies according to the outside temperature. Defrost lasts 6 minutes for Solo models and 9 minutes for Duo models (or 10 minutes for all models if set on “Extended Defrost”). During the defrost cycle, the unit shifts to maximum speed and the dampers close. After defrosting, the unit returns to the operating mode selected by the user.

## 1.6 SPECIFICATIONS

Model	Solo 1.5	Solo 2.0
Width	30 1/4" (768 mm)	30 1/4" (768 mm)
Height	16 1/2" (419 mm)	16 1/2" (419 mm)
Depth	17 1/4" (438 mm)	17 1/4" (438 mm)
Weight	71 lbs (32 kg)	71 lbs (32 kg)
Electrical Supply	120 V, 60 Hz	120 V, 60 Hz
Power Consumption	150 Watts	240 Watts

Model	Duo 1.2	Duo 1.4	Duo 1.9
Width	30 1/4" (768 mm)	30 1/4" (768 mm)	30 1/4" (768 mm)
Height	16 1/2" (419 mm)	16 1/2" (419 mm)	16 1/2" (419 mm)
Depth	17 1/4" (438 mm)	17 1/4" (438 mm)	17 1/4" (438 mm)
Weight	79 lbs (36 kg)	75 lbs (34 kg)	77 lbs (35 kg)
Electrical Supply	120 V, 60 Hz	120 V, 60 Hz	120 V, 60 Hz
Power Consumption	160 Watts	160 Watts	250 Watts

## 2.0 HOW TO OPERATE THE UNIT USING CONTROLS

### 2.1 INSTRUCTIONS REGARDING YOUR CONTROL DEVICES

Determine which controls are installed in your house and identify them in the following tables (this page and the following page). Then, you can proceed to the pages indicated to learn how to CONTROL your unit.

#### MAIN CONTROLS

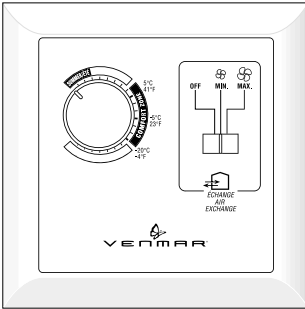

VC0010

**Venta** main control .....Page 9

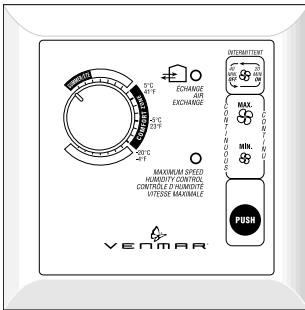

VC0011

**Supra** main control .....Page 10

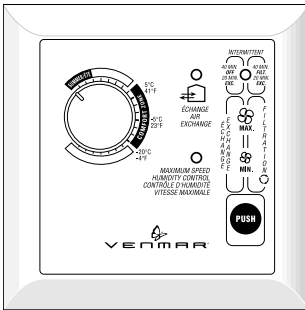

VC0013

**Ultima** main control .....Page 12

## 2.1 INSTRUCTIONS REGARDING YOUR CONTROL DEVICES (CONT'D)

### AUXILIARY CONTROLS

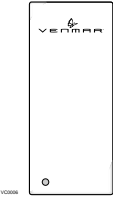

20-min. wireless push-button timer . . . . .Page 14

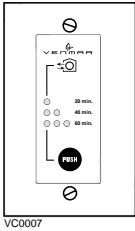

20/40/60-min. push-button timer . . . . .Page 14

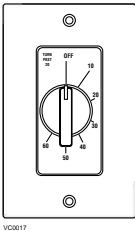

60-min. crank timer . . . . .Page 15

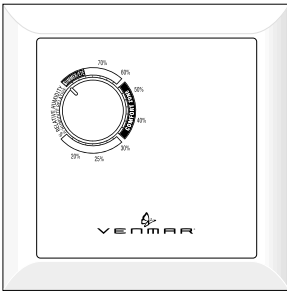

Dehumidistat . . . . .Page 15

VC0009



## 2.2 USING THE VENTA MAIN CONTROL

**Location:** Located in the busiest area of the house.

**Purpose:** To adjust air supply and select desired indoor humidity level.

### ADJUSTING THE AIR SUPPLY CONTROL

a) **Select** speed “MIN.” or “MAX.” using switch **A** (as shown on diagram).

- When “MIN.” (minimum speed) is selected, if the knob **B** is set above the click, the unit will exchange in low speed with the outside and if it is set below the click, the unit will exchange on high speed with the outside until the desired humidity level has been reached.
- When “MAX.” (maximum speed) is selected, the unit will exchange on high speed with the outside either if the knob **B** is set below or above the click.

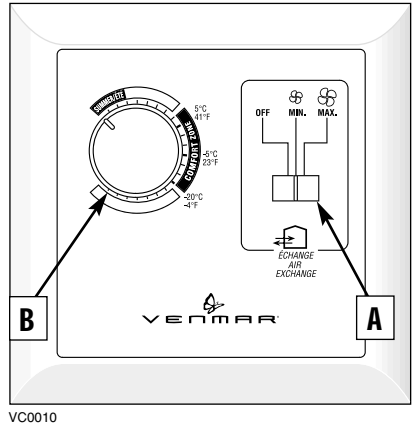

b) To **turn the unit off**, place selector **A** at the “OFF” position. Optional controls, however, may still be active.

### ADJUSTING THE HUMIDITY CONTROL

#### Setting during the summer months:

During this period, unless being afflicted by breathing problems, using the humidity control is unnecessary. Set switch **A** to OFF. (Do not exchange in day time; exchange at night time, if cool outside, or if it is not raining.)

#### Setting during the fall, winter and spring months:

- 1) Determine the humidity level in your house (bring the knob **B** counterclockwise to 20%, then bring it back clockwise slowly until you hear a “click”).
- 2) Set knob **B** to 1% under this temperature level or “click”.

NOTES: 1. Do not select a humidity level below 30%. This could lead to excessive dryness in the air causing discomfort for the occupants.

2. When the humidity level is high, the unit automatically operates at maximum speed. If you change the setting of your “AIR SUPPLY” knob (**B**) at that time, it will remain at maximum speed until the humidity level is reduced, and then switch to the desired setting.

**It is possible (and normal) to experience condensation on your windows when drastic changes in temperature happen (for example: -5°C (23°F) to -20°C (-4°F) within few hours). In that case, we suggest waiting a few days to allow the situation to stabilize.**

## 2.3 USING THE SUPRA MAIN CONTROL

**Location:** Located in the busiest area of the house.

**Purpose:** To adjust air supply and select desired indoor humidity level.

### ADJUSTING AIR SUPPLY CONTROL

a) Press **“PUSH” (A)** until the **“MIN.”**, **“MAX.”** or **“INTERMITTENT”** light indicator appears.

- When **“MIN.”** (minimum speed) is selected, if the knob **B** is set above the click, the unit will exchange in low speed with the outside and if it is set below the click, the unit will exchange on high speed with the outside until the desired humidity level has been reached.

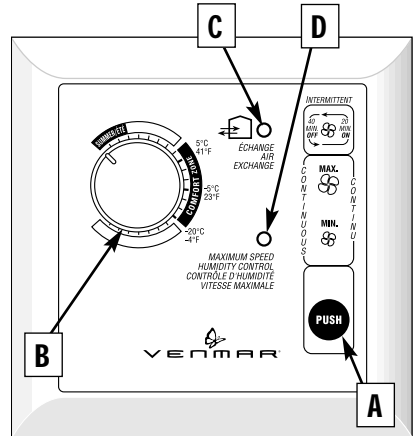

- When **“MAX.”** (maximum speed) is selected, the unit will exchange on high speed with the outside either if the knob **B** is set below or above the click.

- Select **“INTERMITTENT”** (20 minutes minimum speed exchange every hour) when you are away from the house for a few days or when you deem the inside air too dry.

b) To **turn the unit off**, press **“PUSH” (A)** until the **“MIN.”**, **“MAX.”** and **“INTERMITTENT”** light indicators are all turned off.

**NOTE:** Optional controls will still be active. (Indicator **“C”** will be the only one to light up if an optional control is active).

### ADJUSTING HUMIDITY CONTROL

#### Setting during the summer months:

Normally, excess humidity is not a problem during this period, which therefore eliminates the need for the humidity control. Set knob **B** at the **“SUMMER”** position during this period.

#### Setting during the fall, winter and spring months:

Ideally, maintain humidity level within the **“Comfort Zone”** (between 5°C and -20°C), which is the dark area around knob **B**.

To reduce humidity level, turn knob **B** clockwise a notch below the click. The unit will then switch to high speed, lighting up the **humidity light (D indicator)**. When this light goes **“OFF”** (after a few hours or a few days), repeat the same procedure if excess humidity persists.

**NOTE:** If the air is too dry, set your knob **B** back to the **“Comfort Zone”** and use **INTERMITTENT** or turn off the unit.

When the **humidity light (D indicator)** goes **“ON”**, you can still change the mode of operation but your change will take place only when the light goes **OFF**.

## 2.3 USING THE SUPRA MAIN CONTROL (cont'd)

### UNDERSTANDING THE LIGHT INDICATORS

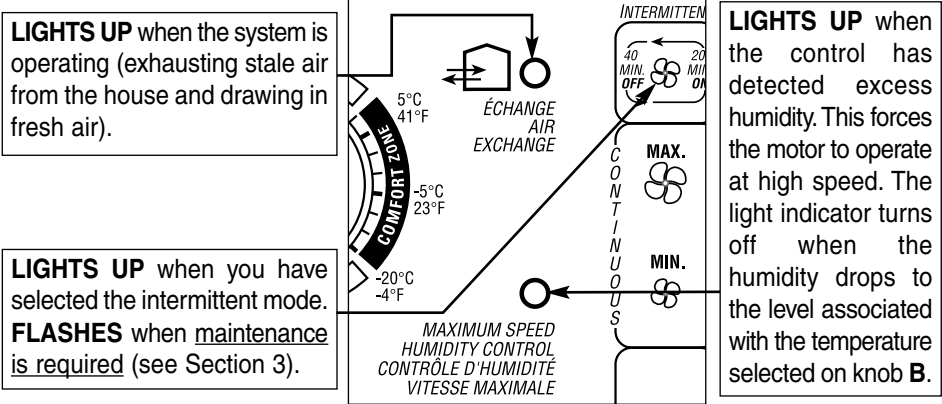

## 2.4 USING THE ULTIMA MAIN CONTROL

**Location:** Located in the busiest area of the house.

**Purpose:** To adjust air supply and eliminate offensive pollutants or to filter air inside the house.

### ADJUSTING THE AIR SUPPLY CONTROL

a) Press **(A)** until the “MIN.,” “MAX.” or “INTERMITTENT” light indicator appears.

- Select “**MIN.**” (minimum speed)  
**GREEN light:** To exchange air with exterior (normal daily operation).  
**RED light:** To filter indoor air allowing exchange with outside air when necessary only (when indoor humidity is too high).

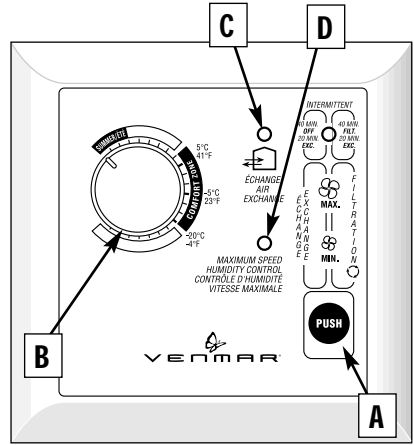

VC0013

- Select “**MAX.**” (maximum speed)  
**GREEN light:** To evacuate excess of pollutants and humidity (parties, odors, smoke, etc.)  
**RED light:** To filter indoor air allowing exchange with outside air when necessary only (when indoor humidity is too high).
- Select “INTERMITTENT”.  
**GREEN light:** To exchange air 20 minutes per hour (unit is OFF for the rest of the time). *Normally used when you are away from the house for a few days or when you deem the inside air is too dry.*  
**RED light:** To filter indoor air for 40 minutes per hour (unit exchanges air for the rest of the time). *Normally used to filter air and allows exchange with exterior at a pre-defined frequency.*

b) To **turn the unit off** press **(A)** until the “MIN.,” “MAX.” and “INTERMITTENT” light indicators are all turned off.

NOTE: Optional controls will still be active. (Indicator “**C**” will be the only one to light up if an optional control is active).

## 2.4 USING THE ULTIMA MAIN CONTROL (cont'd)

### ADJUSTING HUMIDITY CONTROL

#### Setting during the summer months:

Ideally, maintain humidity level within the “**Comfort Zone**” (between 5°C and -20°C), which is the dark area around knob **B**.

To reduce humidity level, turn knob B clockwise a notch below the click. The unit will then switch to high speed, lighting up the **humidity light (D indicator)**. When this light goes "OFF" (after a few hours or a few days), repeat the same procedure if excess humidity persists.

NOTE: If the air is too dry, set your knob B back to the “**Comfort Zone**” and use **INTERMITTENT** (red lights) or turn off the unit.

When the **humidity light (D indicator)** goes "ON", you can still change the mode of operation but your change will take place only when the light goes OFF.

When the **humidity light “D”** goes "ON", you can still change the mode of operation but your change will take place only when the light goes "OFF“.

### UNDERSTANDING LIGHT INDICATORS

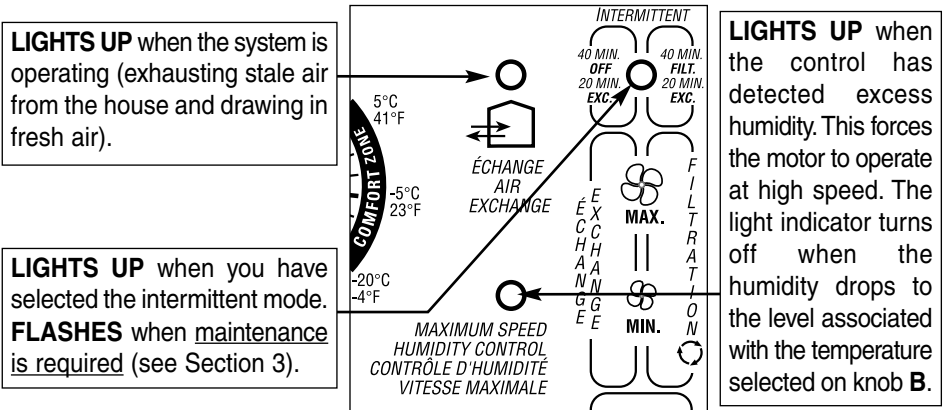

**A) TIMERS**

**Location:** Located in the bathroom or in other locations where there is temporary excess humidity or pollutants.

**Purpose:** To eliminate excess humidity produced by showers or other periodic activities producing pollutants.

**20-MINUTE WIRELESS PUSH-BUTTON TIMER:**

Set the push-button to **ON**: The light indicator lights up for a few seconds and the system exchanges air at high speed for 20 minutes.

**NOTE:** The pushbutton is powered using two 3-Volt lithium batteries with an expected battery life of up to 3 years.

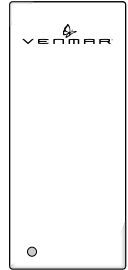

VC0006

**Batteries replacement:** When the batteries are low, the light indicator flashes while activating the push-button.

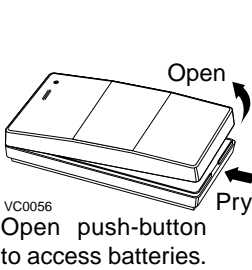

VC0056  
Open push-button to access batteries.

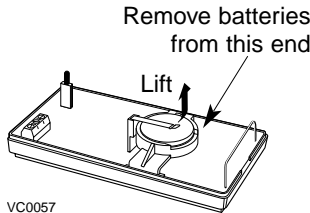

VC0057  
**Gently** lift up end of battery clamp. Slide batteries out.

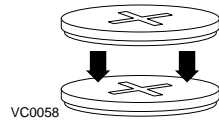

VC0058  
Install two Duracell, type DL2032. Batteries (+) side up.

**20/40/60-MINUTE PUSH-BUTTON TIMER:**

High speed activation times are in multiples of 20 minutes.

- Within 2 seconds, push one time for 20 minutes, two times for 40 minutes, or three times for 60 minutes activation. **Indicator then lights up and the system exchanges air at high speed.**
- Every 5 seconds, the indicator light flashes one time to indicate a 20-minute selection, two times for a 40-minute and three times for a 60-minute selection.
- To stop activation, push one more time. Unit then returns to its previous setting.

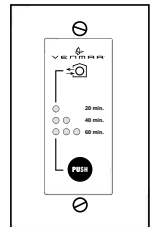

VC0007

## 2.5 USING THE AUXILIARY CONTROLS (cont'd)

### A) TIMERS (CONT'D)

#### **60-MINUTE CRANK TIMER:**

This control makes the system operate at high speed for periods varying from 10 to 60 minutes.

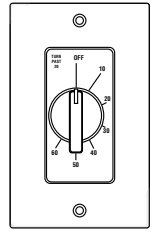

### B) DEHUMIDISTAT

**Location:** Located in the bathroom or in other locations where there is temporary excess humidity.

**Purpose:** To eliminate excess humidity produced by showers or other periodic activities producing humidity.

**In the fall, winter and spring:** Adjust the knob to the desired maximum humidity level.

**NOTE:** Do not select a humidity level below 30%. This could lead to excessive dryness in the air causing discomfort for the occupants.

**In the summer:** Adjust the knob to the "SUMMER" position.

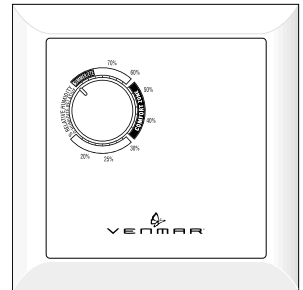

## 3.0 MAINTENANCE

### WARNING

**Dangerous voltage may be present. During maintenance and repairs, the unit must always be turned off, then unplugged. We take great care to minimize sharp edges; however, please proceed with caution when handling all components.**

NOTE: Unit is shown in normal position but can be installed in either the “normal” or “reverse” (upside down) position.

## MAINTENANCE PROCEDURE:

### 3.1 EVERY THREE MONTHS

Regular maintenance should be performed every 3 months. Annual maintenance should also take place every fall season.

1. Disconnect the power supply.
2. Unlatch the door. Lift the panel towards you. Hold it firmly and hit on the right side of the panel. The door should slide to the left.
3. Clean the inside of the door with a damp cloth.

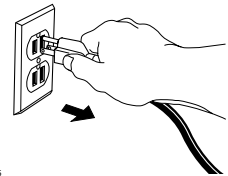

4. A) Clean the ***basic filters***
  - Remove filters.
  - Vacuum to remove most of the dust.
  - Wash with a mixture of warm water and mild soap. You may add bleach if you wish to disinfect (one tablespoon per gallon). Rinse thoroughly. Shake filters to remove excess water and let dry.

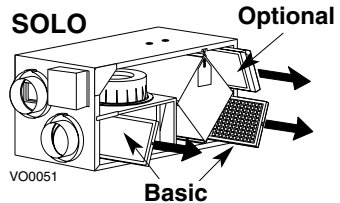
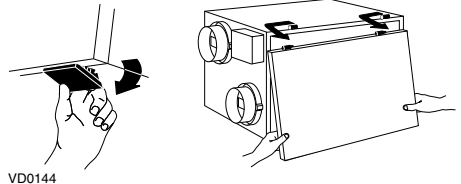

NOTE: Washing the filters in the top tray of the dishwasher is possible, but the aluminum frame might tarnish.

- B) Replace the ***optional filters*** if necessary
  - Do not wash in water.

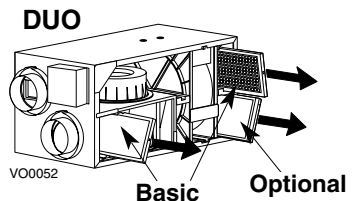



### 3.1 EVERY THREE MONTHS (CONT'D)

---

5. Clean the ***condensation tray*** with a damp cloth.
6. Check the exterior ***air intake hood***:
  - Make sure there are no leaves, twigs, ice or snow that could be drawn into the vent.
  - Clean if necessary.

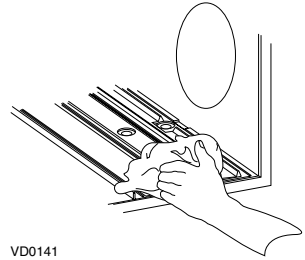

VD0141

#### **CAUTION**

**Even a partial blocking of this air vent could cause the unit to malfunction.**

7. Reassemble the components:
  - Filters
  - Door (The door is secured when you hear a click.)
8. Reconnect the power supply.

## 3.2 ANNUAL MAINTENANCE (FALL)

### WARNING

Dangerous voltage may be present. During maintenance and repairs, the unit must always be turned off, then unplugged.  
We take great care to minimize sharp edges; however, please proceed with caution when handling all components.

Repeat steps 1 to 6 from the previous Section and continue with the following steps:

### CAUTION

Handle the recovery module with care.

#### 1. Clean the recovery module

##### A- Polypropylene core (Solo)

- Remove the recovery core.
- Let it soak in a mixture of cold or lukewarm water and mild soap (dishwashing liquid).
- Rinse thoroughly.
- Shake the core to remove excess water and let it dry.

##### SOLO

VD0142

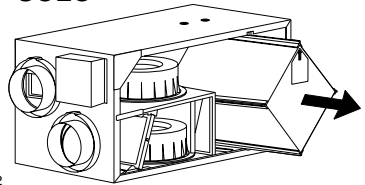

##### B- Thermal wheel (Duo)

### CAUTION

This type of recovery module cannot be washed with water.

- Disconnect the thermal wheel wires.
- Remove the thermal wheel.
- Remove dust using a vacuum cleaner with a soft brush attachment.

##### DUO

VD0143

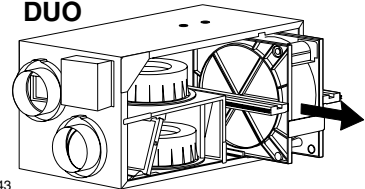

## 2. Clean the centrifugal fan wheels

**A** Disconnect the fan motor wires.

VE0067

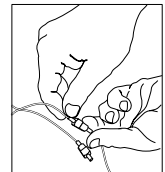

2. Clean the centrifugal fan wheels (cont'd)

**B** Disconnect the rod activating the square damper.

**C** Remove the two screws securing the fan assembly.

**D** Pull the fan assembly out of the unit.

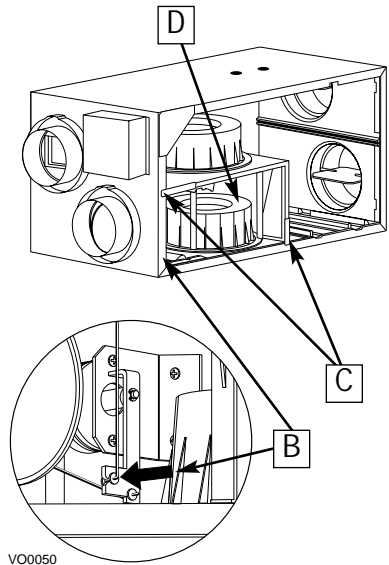

**E** Check for any dust accumulation on the blades.

**CAUTION**  
Do not oil the motor! It is already permanently lubricated.

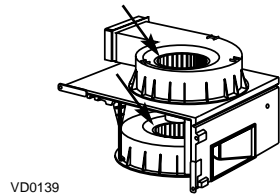

**F** Clean with a small brush if necessary.

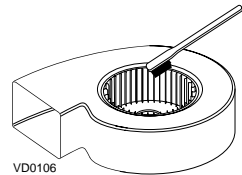

3. Put the components back in place (cf: section 1.1.):

- Fan assembly (screws, damper rod, fan motor wires)
- Recovery module
- Filters
- Door

4. Reconnect the power supply.

## 4.0 TROUBLESHOOTING

If you think your unit is malfunctioning, check some of the following.

	TYPE OF PROBLEM	TRY THIS...
1	Nothing works.	<ul style="list-style-type: none"><li>• See if the unit is plugged in.</li><li>• See if the unit is receiving power from the house circuit breaker or fuse.</li></ul>
2	All light indicators on the wall control system are flashing (every 8 seconds).	<ul style="list-style-type: none"><li>• Unplug the unit, wait 30 seconds, then reconnect. If the problem continues, contact your installer.</li></ul>
3	Light indicator flashes or doesn't light while activating the wireless push button.	<ul style="list-style-type: none"><li>• Open the push button casing and change the batteries. They are low (see Section 2.5).</li></ul>
4	Condensation on windows. (Air too humid.)	<ul style="list-style-type: none"><li>• Adjust the humidity control knob as per instructions (see Section 2).</li><li>• Operate the unit at maximum speed (MAX.) during activities generating excess humidity (family gatherings, extra cooking, etc.).</li><li>• Leave curtains half-open to allow air circulation.</li><li>• Store all firewood in a close room with a dehumidifier or in a well ventilated room, or store the wood outside.</li><li>• Keep the temperature in your house above 18°C (64°F).</li></ul>
5	Air too dry.	<ul style="list-style-type: none"><li>• Do not adjust your humidity control below -20° C (30%).</li><li>• Operate the unit at low speed (MIN.).</li><li>• Temporarily switch to the intermittent mode.</li><li>• Temporarily use a humidifier.</li></ul>
6	Air too cold at the air supply grille.	<ul style="list-style-type: none"><li>• Make sure the outside hoods are not blocked.</li><li>• Operate the unit at low speed (MIN.).</li><li>• Have the system's balancing checked.</li><li>• Have the unit's defrost system checked.</li><li>• Install a duct heater.</li></ul>

If the problem persists, contact your installer at the telephone number and address indicated on the first page of this manual or call the following phone number for assistance:

- 1-800-567-3855 (Canada and United States)